

Thinking beyond
previous expectations.

The new dimension of High Precision Cutting Tools



Made in
Germany

LPT – the new synonym for "efficiency".

Fast and easy with LeistrizPerformanceTools

Application

Facing

External chamfering

Internal chamfering

Longitudinal turning

Centering

Facing

Diameter d

12 mm

External chamfering

Angle α

45°

Length b

2 mm

Longitudinal turning

Diameter D

16 mm

Length x

6 mm

Material

Stainless steel

Set filter

The perfect fit for your machining task

Our **LeistrizPerformanceTools (LPT)** can be found in the standard program as **LPTline**. These tools are of course available from stock.

You have individual wishes regarding dimensions, material, tipping, coating? With pleasure! In our **LPT+line** we manufacture your individual request according to your drawing.

Simply go to our corresponding configurator and enter your information! We will do the rest.

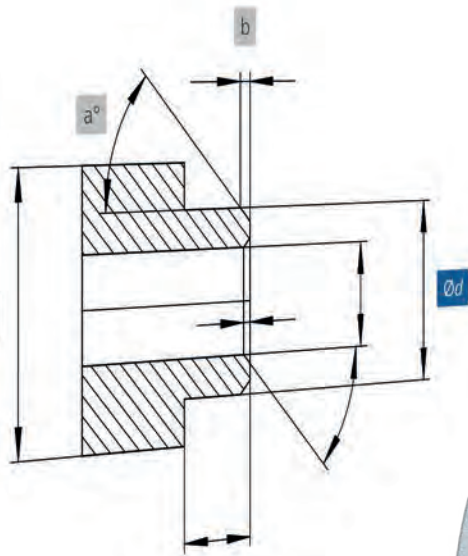

+line

For special challenges: Request your individual turning tools directly from us now!

> Request custom configuration

> Request custom configuration
now!
individual turning tools directly from
our website: [www.wz.wz.de](#)

And that's how it works!

In our overview catalog you have the possibility to assemble your required tool quickly and easily with the help of our configurator. In each chapter you will find the corresponding URL or a QR code, which will take you directly to the online matrix. For standard tools, you select the appropriate design and initiate the ordering process. For special designs, please enter the required information together with the drawing.

It couldn't be easier!

Best in class 2021.

4

Whirling rings

p. 32/33

1

Work rest blades

p. 10/11



5

Keyseating tools

p. 40/41

3

Milling Tools with index able inserts p. 30/31



2

End finishing tools p. 18/19

» *Your challenge – Our high precision cutting tool. The perfect combination for your production.*

Stefan Kühnle
Vice President Tooling

Sometimes established tool solutions are needed. Sometimes you may have to rethink and take up new ideas. Our claim is to combine both approaches – of course only where it makes sense and both productivity and cost-effectiveness can be increased. Depending on the production task, we combine the tried and tested with (customized) innovations for you.

On the following pages you will find our standard tools as well as high-end solutions. Let us inspire you!

We look forward to your challenge!



INDEX

Grinding

Centerless grinding
Individual shapes
Thread rolling
Reconditioning

08

Turning

End finishing
Profiling
ISO-Turning

14

Drilling

Solid drilling
Reaming
Spiral drilling

22

Milling

End milling
Insert milling
Whirling

28

Keyseating

Through hole
Blind hole

38

Sawing

Industrial sawing

42

Laboratory equipment

Microtomy

46

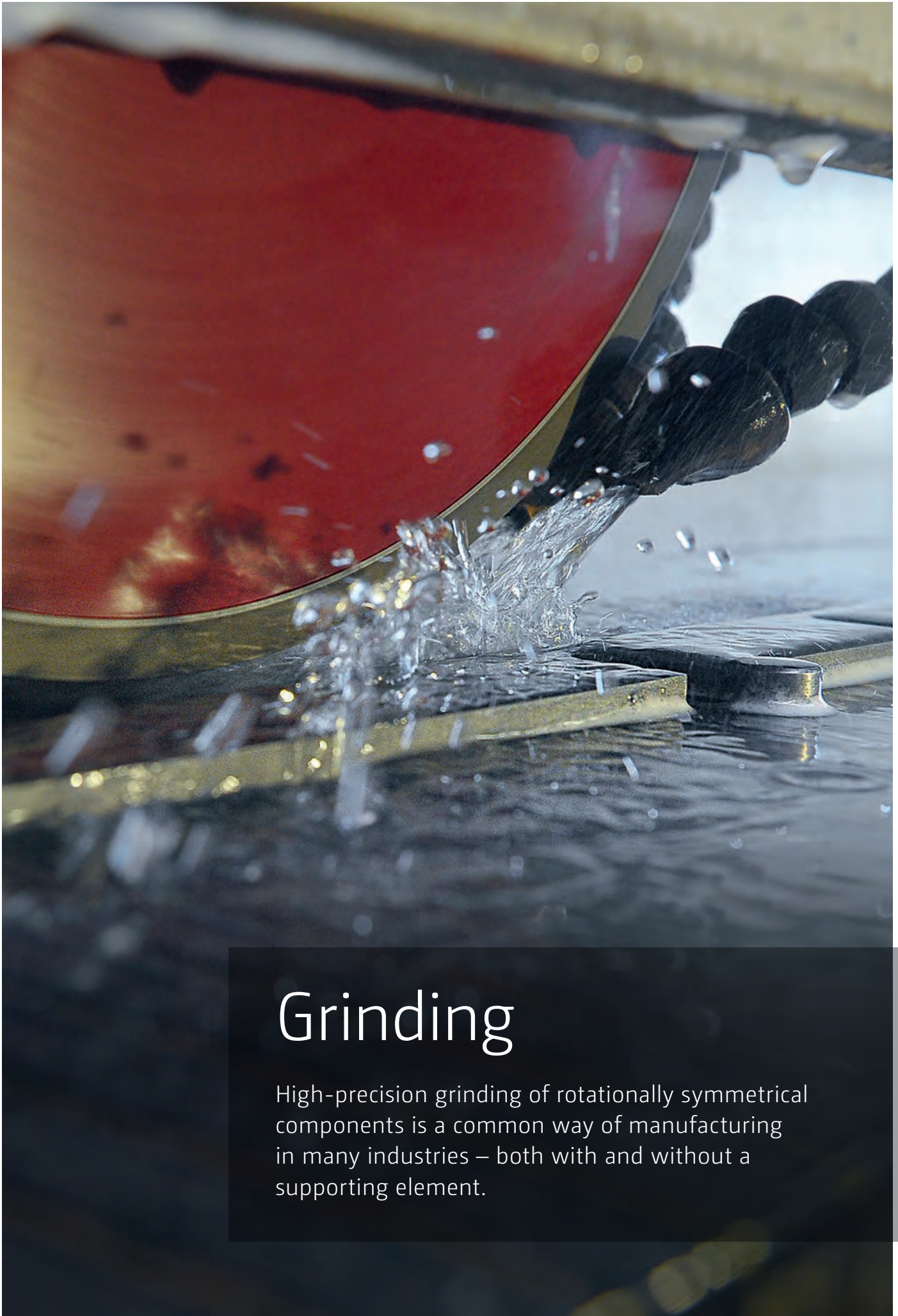

Grinding

High-precision grinding of rotationally symmetrical components is a common way of manufacturing in many industries – both with and without a supporting element.



THROUGH-FEED BLADES



PRISM BLADES



PLUNGE CUT-/STEPPED BLADES

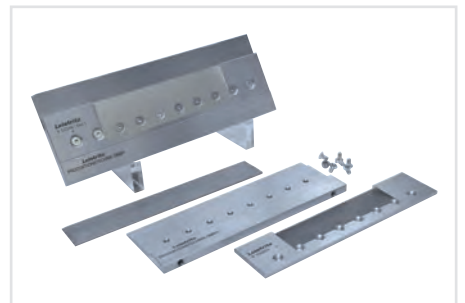

SCREWED BLADES



CORRUGATED BLADES



CUSTOMIZED SOLUTIONS

Guids you through the final finish.

The art of guidance

1

Individual Form

Mounting, stops and steps are individually designed and manufactured for your workpiece.

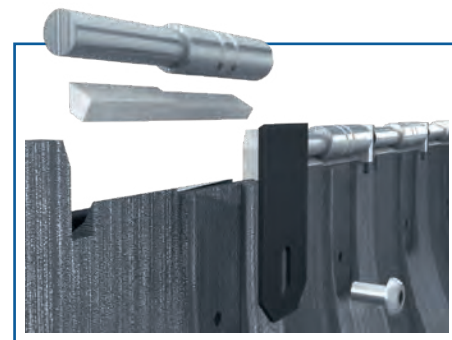

2

Precision counts

With tolerances in the μ range for steps, Leistritz work rest blades are perfectly suited for high precision applications.

3

Maximum length

Leistritz work rest blades can be produced up to a length of 3 m. This means that even long components can be ground in just one pass.

➤ Diverse design competence – according to manufacturer's specifications, customer drawing or as a new Leistriz design

4

Individual Tipping

Whether carbide, PCD or ceramic – we offer the optimum equipment for every application in order to maintain the precision of your work rest blade for as long as possible.

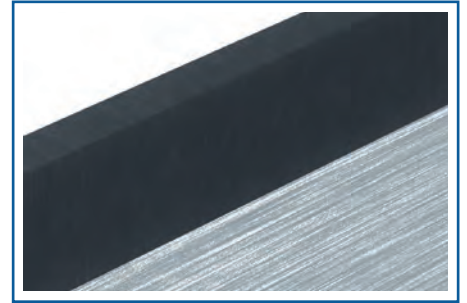

5

Maschine brand-independent

Leistriz work rest blades can be used on all common grinding machines. This means you are always on the safe side, even when changing machines.

Leistriz express service

On request, your work rest blades will be with you after only 15 working days.



We can also produce complex individual shapes: Whether step work rest blades, multi-chambers for grinding several workpieces or individual shapes – we manufacture entirely according to your individual requirements.



BEARING RAILS



SUPPORT SHELS



GRINDING STARS

Thread rolling

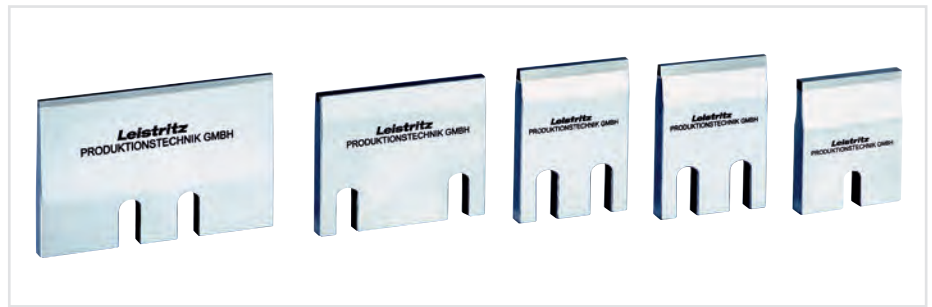

On special thread rolling machines, the material is cold-formed by two forming rollers on the workpieces. As with centreless grinding, a thread rolling support is required in the rolling process as a supporting element for the workpieces.

Reconditioning



BEFORE



AFTER

Not new, but just like new: With reconditioning in original equipment quality, we offer an absolutely economical solution.

LEISTRITZ HIGH PRECISION TOOLS leaves nothing to be desired.

Take advantage of the Leistriz Express Service: Regrinding is now even faster. In only 5 working days your rail will be like new again. And this applies not only to Leistriz rails, but also to rails from other manufacturers.

Configure your tool!

LPTline

Learn more about our complete range of work rest blades and configure your suitable product!

LPT+line

For special challenges: Request your individual work rest blades directly from us now!



tools.leistriz.com/grinding



Turning

Turning is by far the most traditional form of machining. We have looked at this area from the perspective of the highest possible productivity. We will find the technically most suitable solution for almost every task.



OVERCUT (OVERTURNING)



END FINISHING TOOLS



END FINISHING TOOLS MINI



TUBING TOOLS



TOP TURN (END SHAPING)

The new dimension of turning. **OverCut.**

Axial turning with multiple diameters

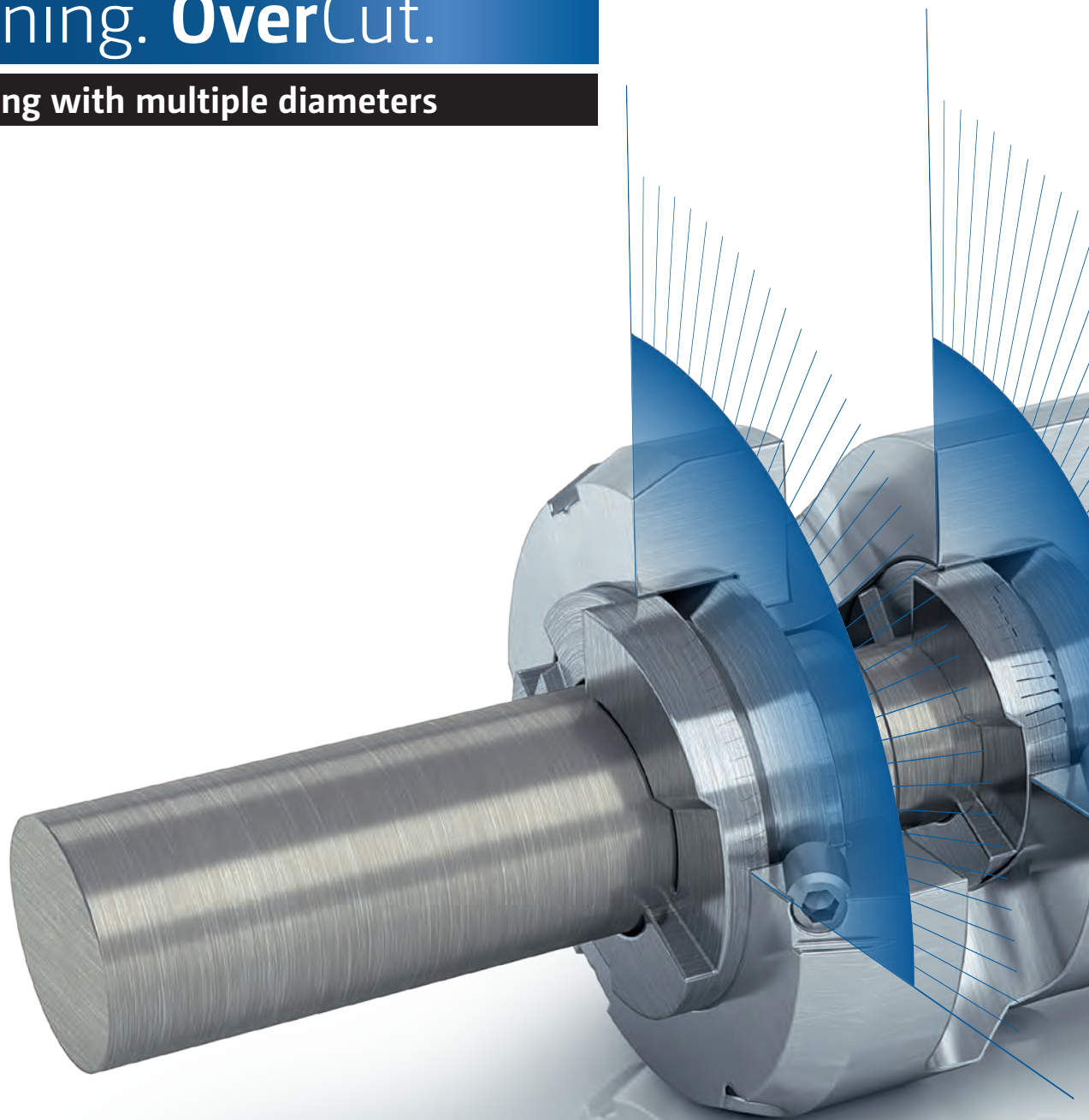

1

No radial displacement

Due to the radially arranged cutting inserts, the force is evenly distributed on the workpiece.

2

Exchangable cutting inserts

The cutting inserts can be changed to suit the application. This means that you are always well prepared for changes.

- Cost- and time-saving multifunctional tool
- Manufacture up to 6 x faster
- Several production steps in one operation



3

One body for everything

With only one basic body a wide range of diameters can be machined.

4

Sufficient Cooling

The Leistriz OverCut is available with internal coolant supply. The chips are flushed out, the tool life of the tool inserts is ultimately considerably increased.

Process analysis included

Our experts analyse your current process with you and develop the optimal tool from it.

The pacemaker for an perfect end.

Up to 5 steps in one

1

Highest economic efficiency

By using profile inserts, even complex shapes can be machined.

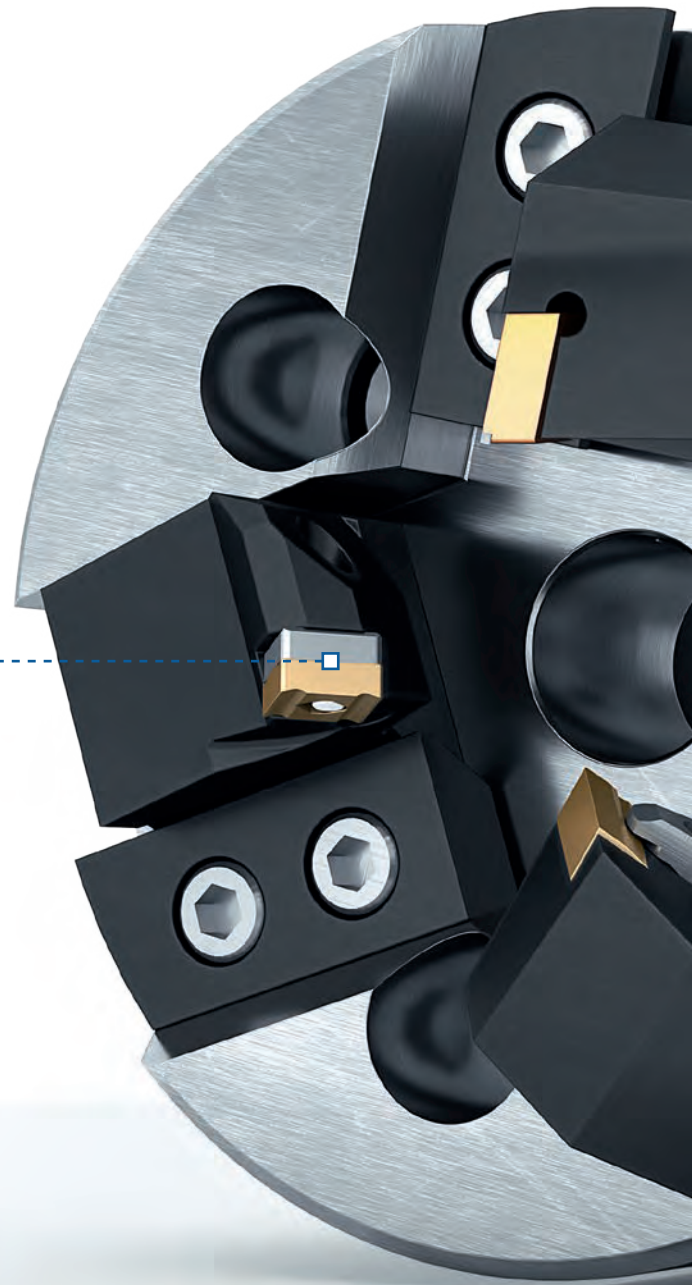

2

Exchange accuracy

The insert seat grinding enables easy exchange.

3

Outstanding stability

The cutting pressure is applied over the entire width of the insert, and thus enables optimum force transmission.

- **Complete supplier: Inserts and tool bodies in special and standard design can be freely combined**
- **Short delivery times**



4

Quick change saves time

The Leistritz clamping system allows the profile inserts to be changed inside and outside the machine.



Process analysis included

Our experts analyse your current process with you and develop the optimal tool from it.

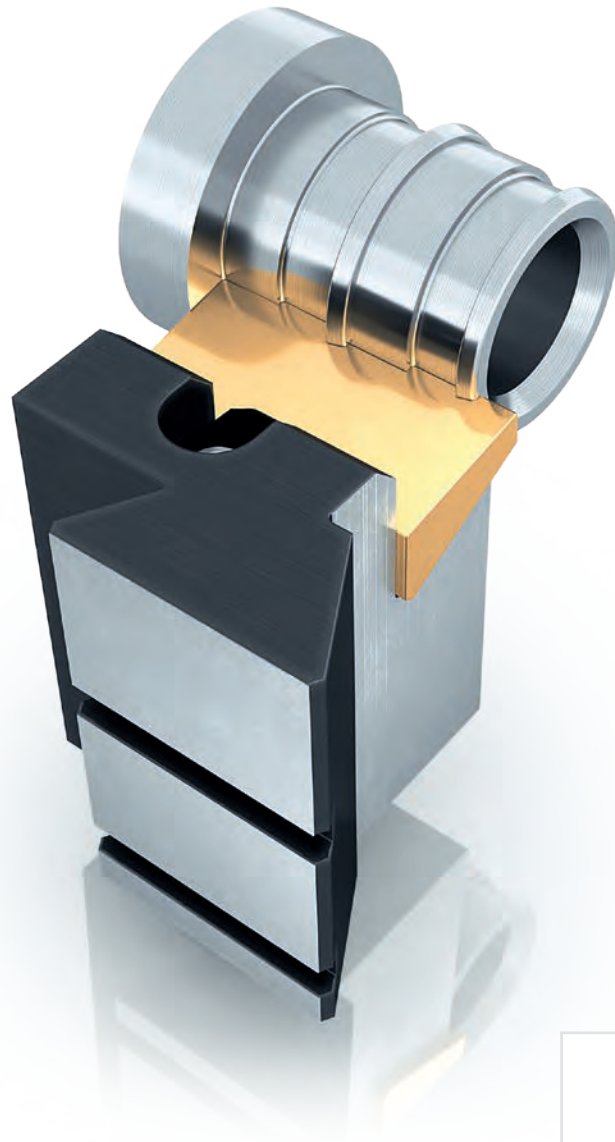

Complex turned part contours require high-performance profile cutting tools for the economical production of these turned parts. At the Leistriz Profile Centre, we will be happy to take care of the profile design and cutting layout for you on request.



INDIVIDUAL INSERTS



FROM WORKPIECE



TO TOOL

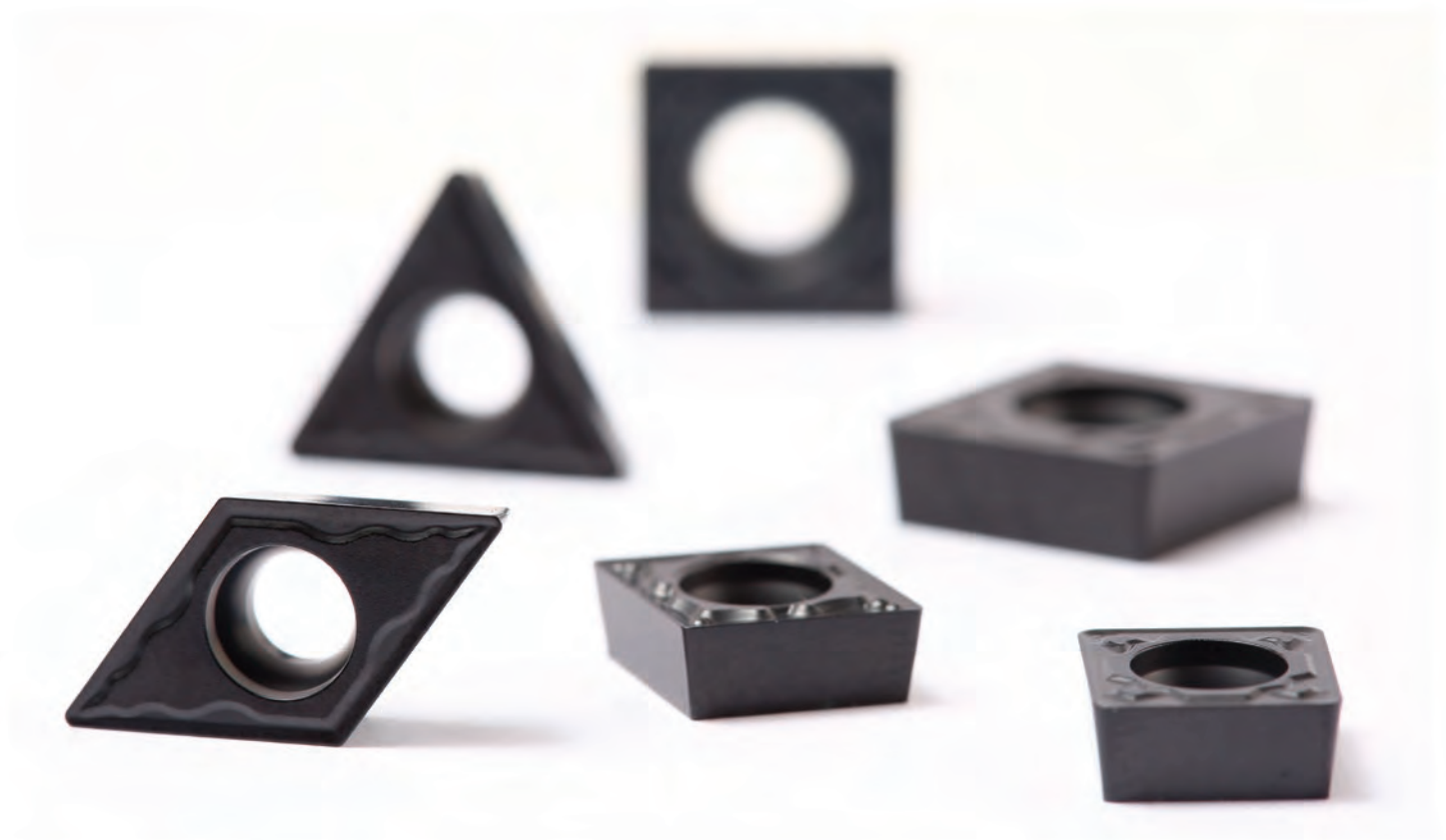

For us, being a partner means always having the most economical solution for your task in mind. That is why, in addition to our special solutions, we also offer a standard programme for positive turning inserts.

Configure your tool!

LPTline

Find out more about our entire range of turning tools and configure your suitable product!

LPT+line

For special challenges: Request your individual turning tools directly from us now!



tools.leitritz.com/turning

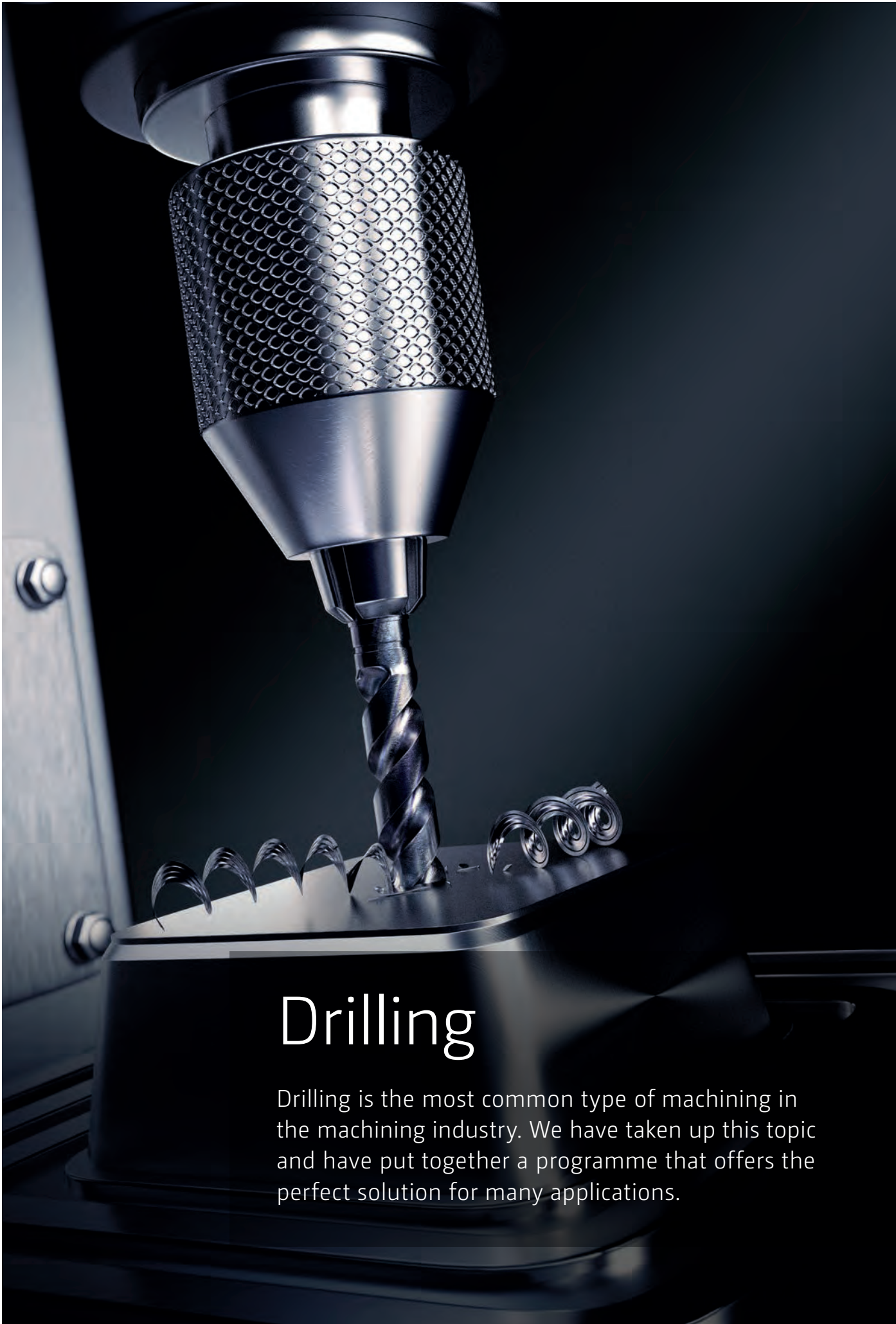

Drilling

Drilling is the most common type of machining in the machining industry. We have taken up this topic and have put together a programme that offers the perfect solution for many applications.

Drills at a glance

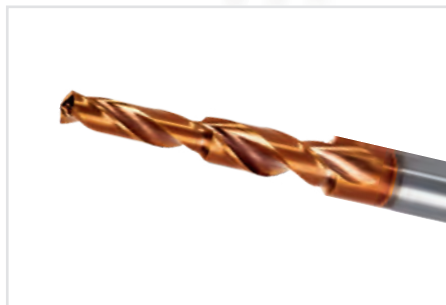

SOLID CARBIDE DRILLING

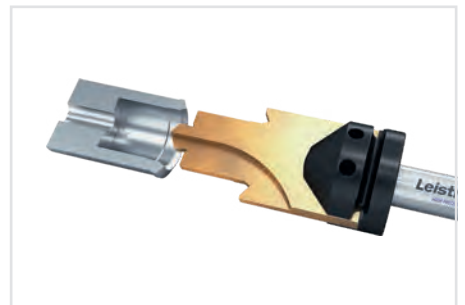

INSERT BASED DRILLING



REAMING



SOLID CARBIDE DRILLING

Skilfully holed with interchangeable inserts.

Drilling with a maximum of flexibility

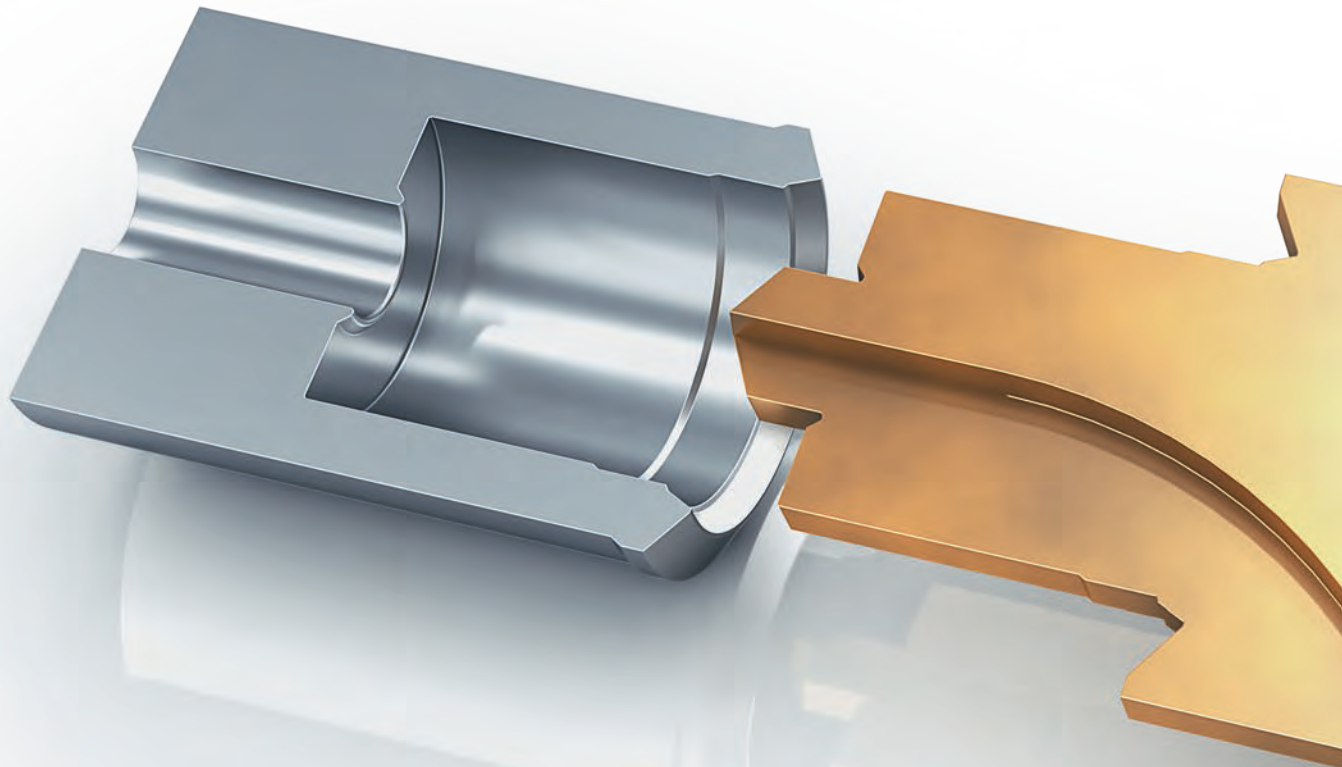

1

Internal cooling

The designs with individual coolant connections are possible. This significantly increases the service life of the tool.

2

Maximum stability

Due to positive insert seating, even materials with high strength are drilled safely and very easily.

3

Easy exchange inserts

Different exchangeable inserts can be used with the same tool holder.

- Diameter 1 - 60 mm
- Optimum economy due to interchangeable inserts
- Can be used on all common machine types



4

One for all

Different interchangeable plates can be used with the same tool holder. This shortens the set-up times enormously.

Process analysis included

Our experts analyse your current process with you and develop the optimal tool from it.



Leistriz offers solid carbide reamers to complement the solid carbide drill programme for economical and reliable fine machining of your bores. The reamer programme includes diameters from 0.95 to 20 mm. In addition to the standard reamer NC, there are the high-performance reamers S2 and VA, which meet the highest demands on cutting speed and tool life.

Solid carbide drilling

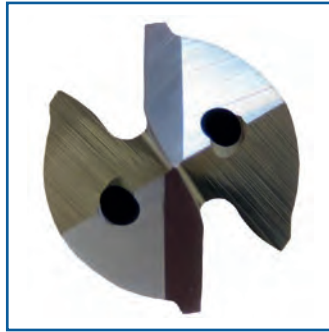

The machining process includes modern solid carbide drills. Our experts use the Leistritz delivery programme in standard and customised versions.

Configure your tool!

LPTline

Learn more about our entire range of drills and configure your suitable product!

LPT+line

For special challenges: Request your individual drills directly from us now!



tools.leistritz.com/drilling



Milling

The production of complex parts requires sophisticated tools! High process reliability, tool life and surface quality are particularly important in milling. With Leistritz solid carbide milling cutters, we have the right tool for your machining task. Special milling cutters with short delivery times are our strength. Of course, we also offer standard end mills for roughing and finishing.



END MILLING



INSERT BASED MILLING



WHIRLING

The cutter that shows teeth.

Maximum number of cutting edges for highest productivity

1

Highest product quality

With the latest manufacturing technologies, we produce the maximum in repeat accuracy.

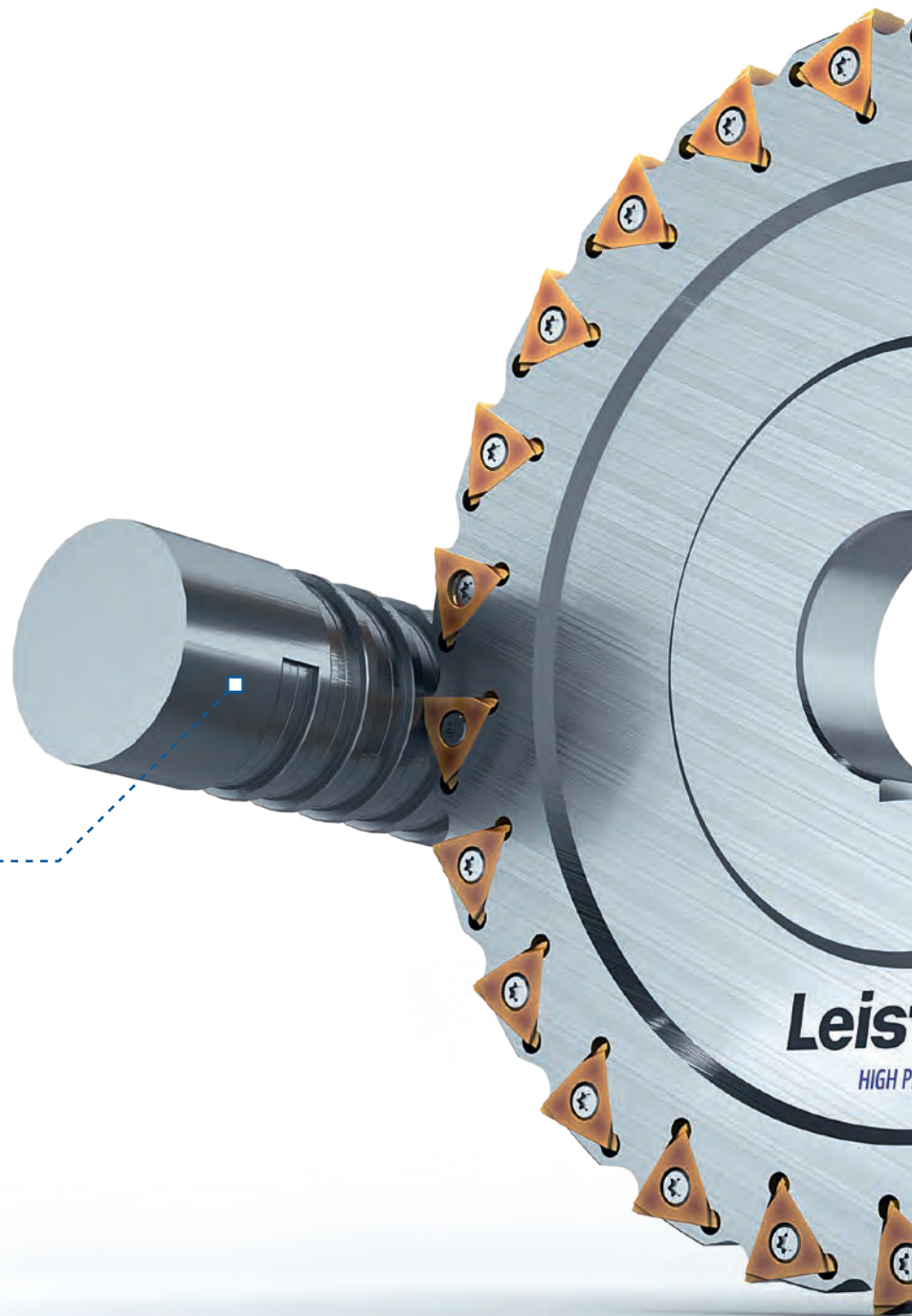
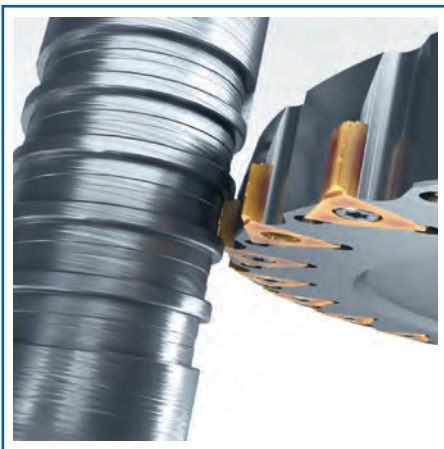

2

High economic efficiency

By using multi-edged inserts you increase the lifetime of the inserts enormously.

3

Maximum flexibility

The cutting edges of the profile inserts are individually adapted for your application.

- Various coatings – suitable for your application and processes
- Full-range supplier – with standard and individual solutions for every application

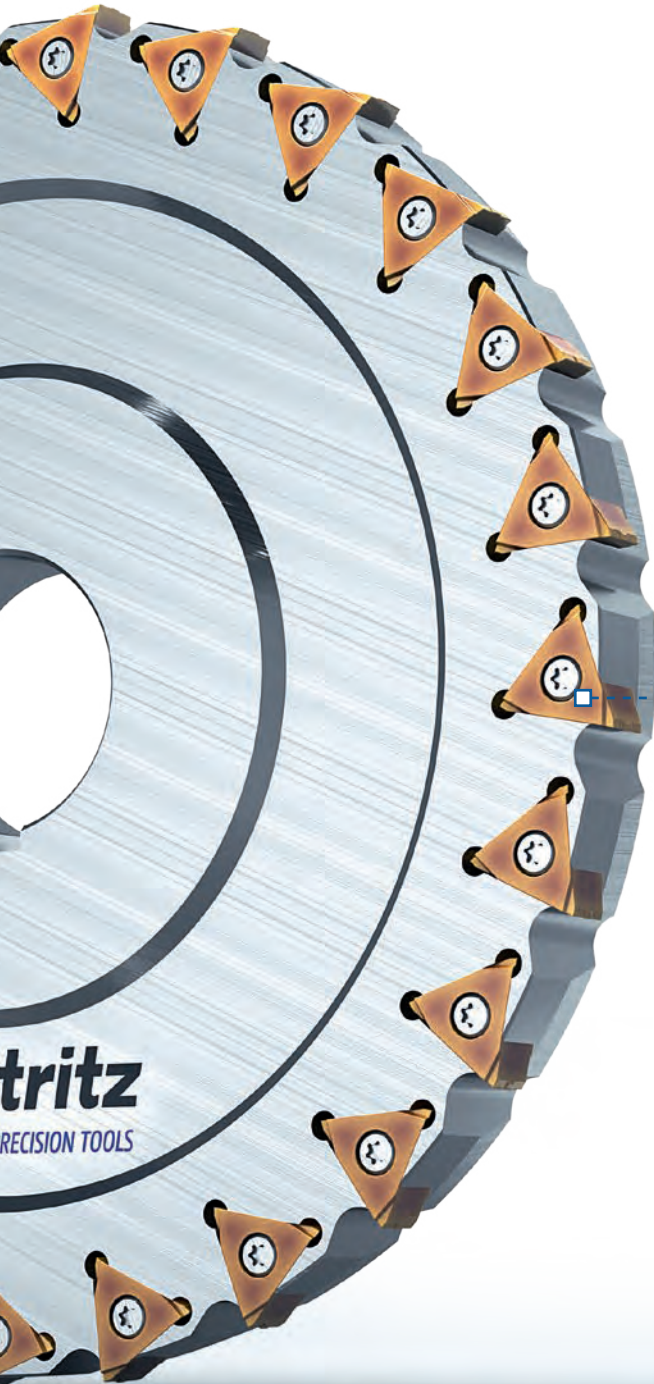

4

Innovative mounting

The plates can be changed with maximum precision in a very short time – with only one screw.

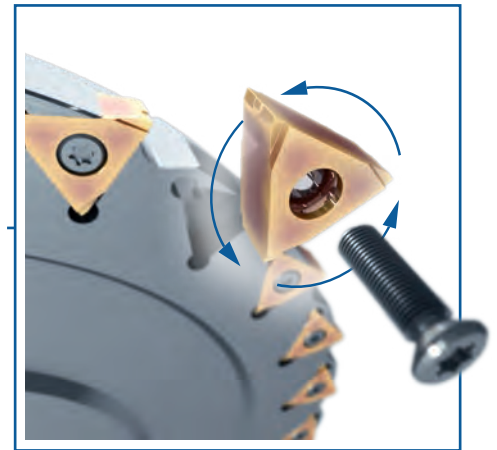

Our extra for you

We will provide you with the appropriate special assembly tools for the easy insert change.

The whirlwind for profile milling.

Profile accuracy down to the μ

1

Highest material removal rate

The optimum process design of the whirling tool and machine reduce the number of number of passes required can be can be minimised.

2

Optimum tool design

Number of teeth, chip removal, heat management as well as insert strategy are individually adapted to your application.

3

Maximum tool life

Thanks to perfect geometric design and a wide range of coatings, fast wear is a thing of the past.



➤ For Leistritz whirling machines as well as for other Machine tool brands – with our tools you get the maximum out of your whirling process.



4

Regrinding service

Save time and money:
The cutting edges can be
reground several times.

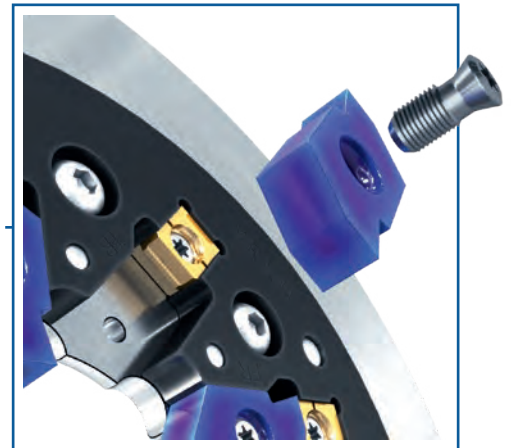

Process analysis included

Our experts analyse your current
process with you and develop the
optimal tool from it.



When milling, high process reliability, tool life and surface quality are important. With Leistriz solid carbide milling cutters, we have the right tools for your machining task.



In our new programme for milling with inserts on ISO basis, the offer ranges from the classic milling application to the specially manufactured tool.

Special milling for individualists.

Special milling tools for every task



1

Process reliability

Rely on consistent quality, even after a large number of machining operations. With Leistriz special cutters you always produce precisely.

2

Maximum tool life

Through individual coatings you minimise wear and extend the lifetime of the tool to maximum.

3

High surface quality

Optimal geometry, paired with the best materials, provides surfaces that are second to none.

- Individually designed and manufactured for your requirements
- Diameter 1 - 25 mm



Process analysis included

Our experts analyse your current process with you and develop the optimal tool from it.

Configure your tool!

LPTline

Find out more about our entire range of milling cutters and configure your suitable product!

LPT+line

For special challenges: Request your individual milling cutters directly from us now!



tools.leistritz.com/milling



Keyseating

Keyseating offers you a quick and accurate alternative to broaching and shaping. Thanks to our many years of experience in the construction of keyseating machines, we have comprehensive application knowledge. Construction – replacement – regrinding, everything is covered with our portfolio.

Keyseating tools at a glance

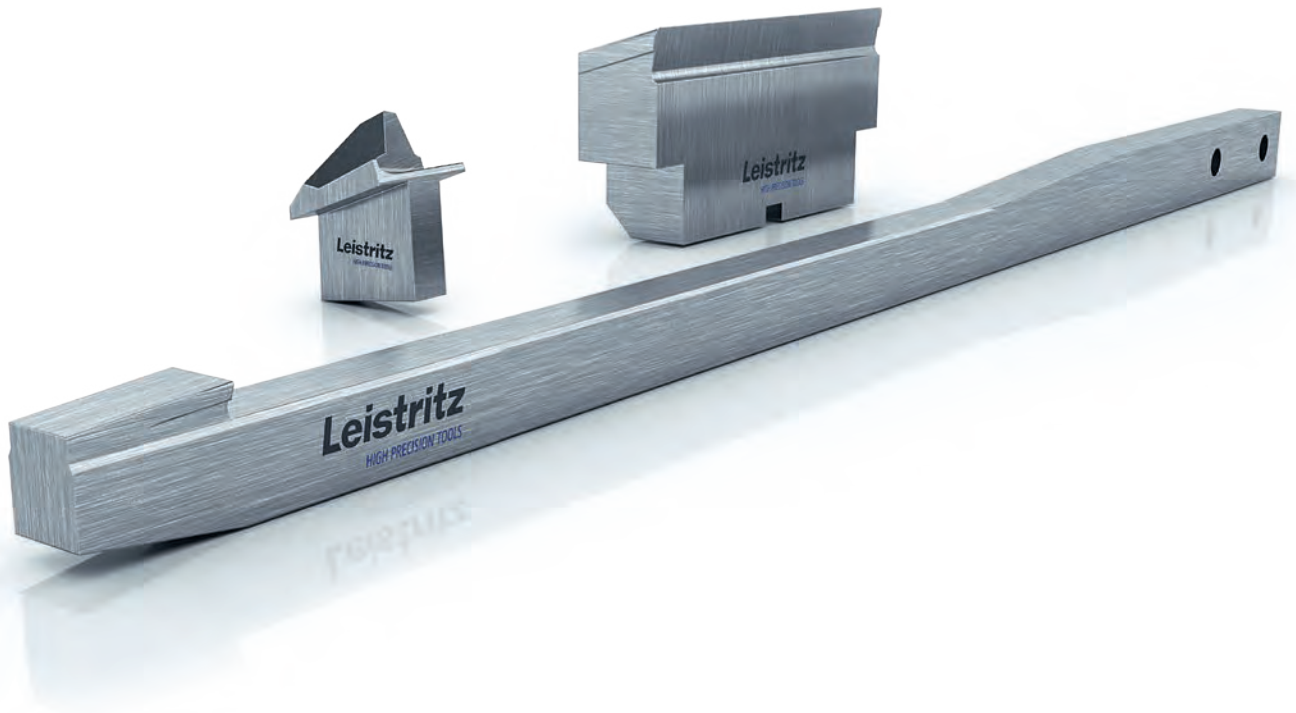

KEYSEATING INSERT TYPE A



KEYSEATING INSERT TYPE B



KEYSEATING INSERT TYPE C



KEYSEATING TOOLS

Flexibility in use – razor-sharp thought out.

The new dimension in keyseating tools

1

Flexible tolerances and shapes

(Almost) Nothing is impossible. With Leistritz keyseating tools solutions for all shapes – and with optimum tolerances.

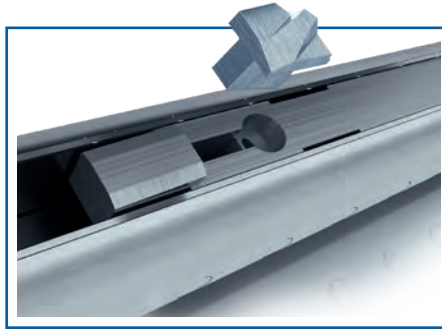

2

Keyseating tools for all brands

With Leistritz keyseating tools you can also bring other manufacturers' products up to the state of the art. Leistritz supplies tools for all well-known machine manufacturers and gets the best out of your machinery.

- Simple handling for short set-up times
- Economical production even of small batches and individual parts



3

Highest quality

Leistriz keyseating tools are ground, not eroded. Thus, your process will also deliver the best possible results in the long term.

4

Know-how in keyseating

Our many years of experience in the in the field of mechanical engineering enables us to offer you the best possible support for your project.

Large stock availability

Standard tools are available in many versions directly from stock.

Configure your tool!

LPTline

Learn more about our complete range of keyseating tools and configure your suitable product!

LPT+line

For special challenges: Request your individual keyseating tools directly from us now!



tools.leistriz.com/keyseating



Sawing

Industrial sawing involves a number of pitfalls. Who could be a better partner at your side than the experts for metalworking of any kind? With our broad expertise in machining processes, we are also there for you in the area of sawing. And with our regrinding service, your saw blades will stay in use for longer.



SAW BLADES

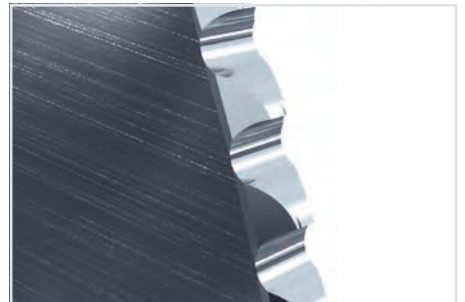

REGRINDING

A well-rounded option for your productivity.

High-Quality saw blades for outstanding results

1

Optimised production costs

Adapted to your process, Leistriz saw blades optimise your production and minimise costs.

2

Highest quality

The well-known Leistriz quality ensures outstanding results – with maximum tool life.

3

Enormous variety of sizes

With a diameter of 15 - 750 mm and a thickness of 0.1 - 12 mm, you are equipped for every task.

Regrinding service

Not new, but just like new: With reconditioning in original equipment quality, we offer an absolutely economical solution.

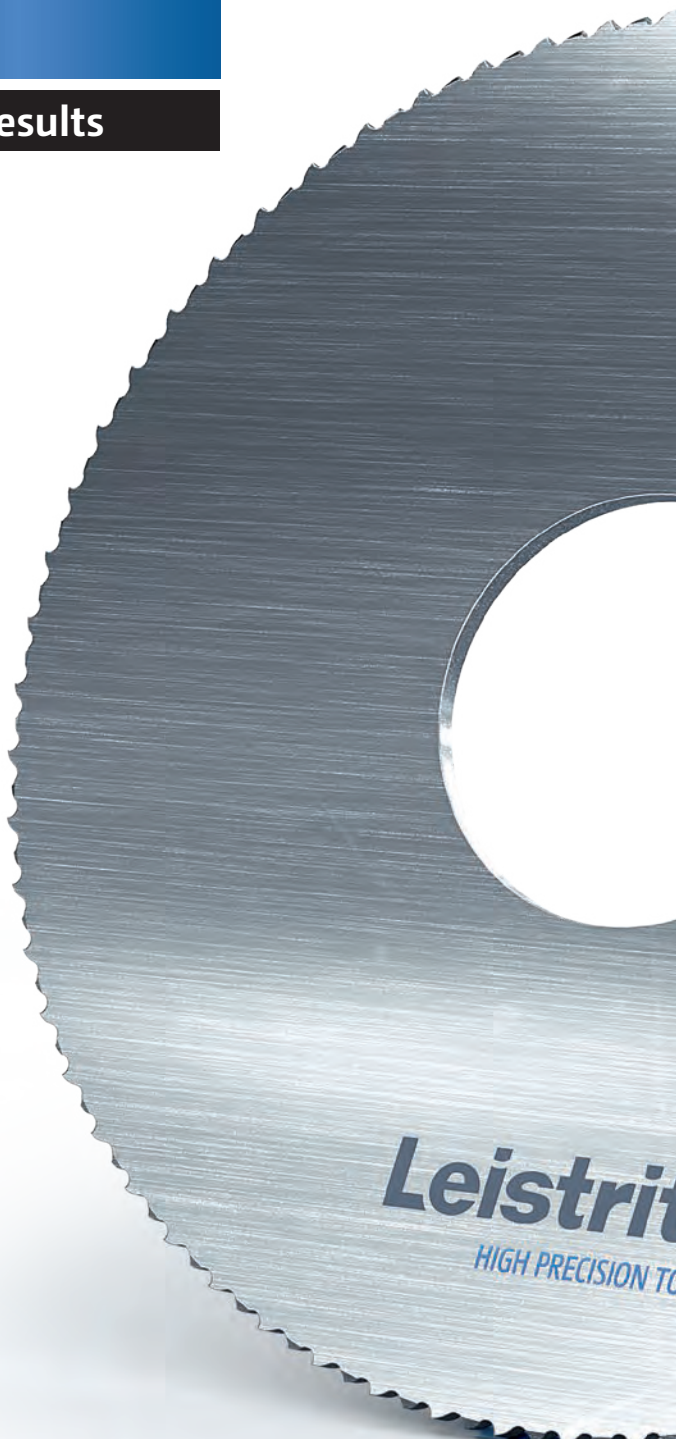

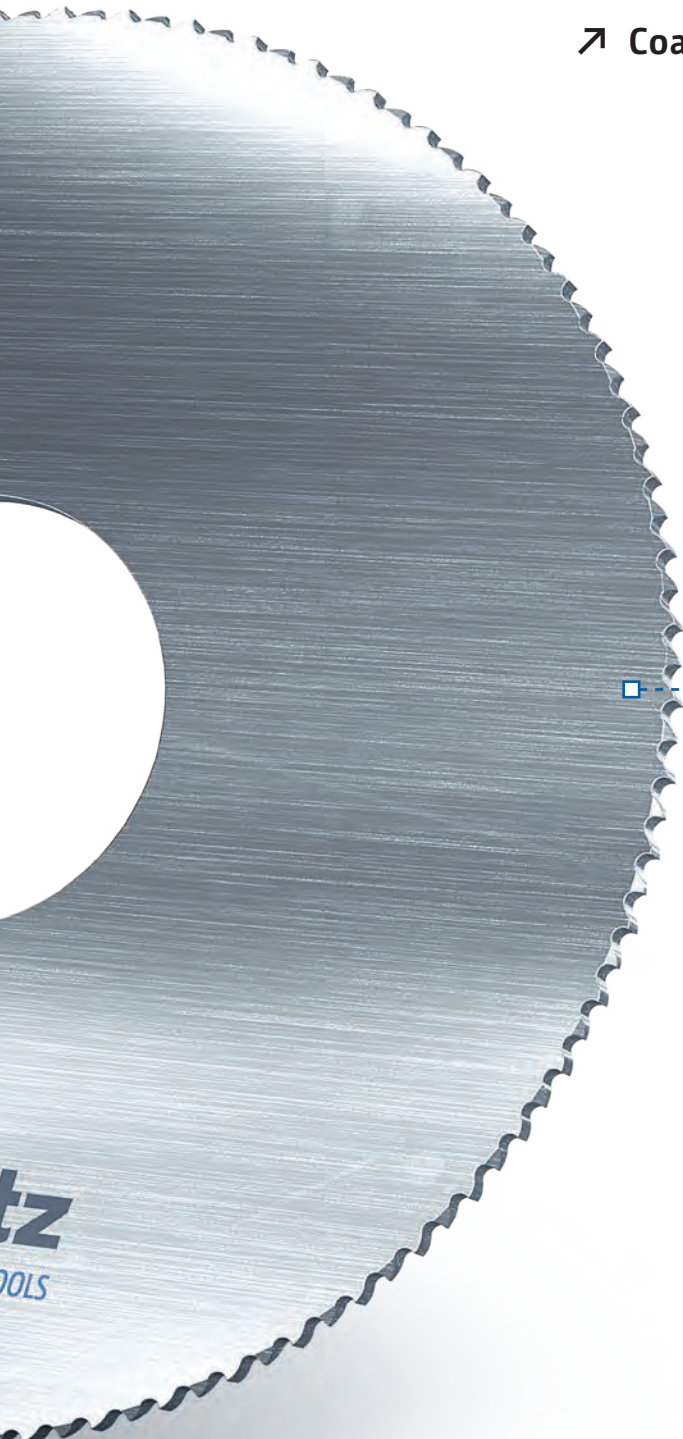

- Made of HSS/DMo5, HSS-E/Co5 or solid carbide
- For all common machine types
- Coated and uncoated

4

Any tooth shape possible

Whether according to DIN standards or individually designed for your process – you define and we deliver precisely.

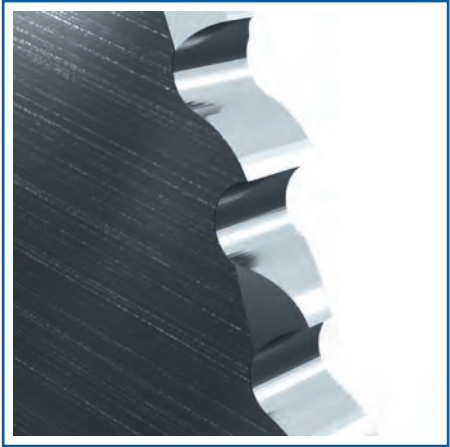
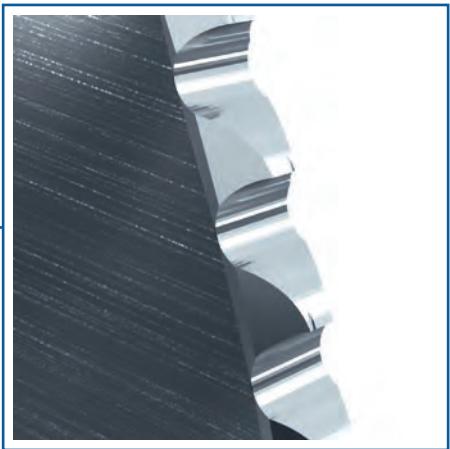

Configure your tool!

LPTline

Learn more about our complete range of saw blades and configure your suitable product!

LPT+line

For special challenges: Request your individual saw blades directly from us now!



tools.leitritz.com/sawing



Laboratory equipment

Highest laboratory quality – mass produced. With our microtome knives, you get a high-precision solution, without the need for further processing steps, such as polishing. We are your partner from design to assembly. Whether for tissue samples or for material analyses, with Leistriz microtome knives you are able to perform high-precision cutting. We are also your partner when it comes to "regrinding" – you will get your knives back as good as new quickly.

Precision down to the μ

With a surface finish of 0.2μ and a cutting radius of 0.03 mm , cuts are maximally clean.

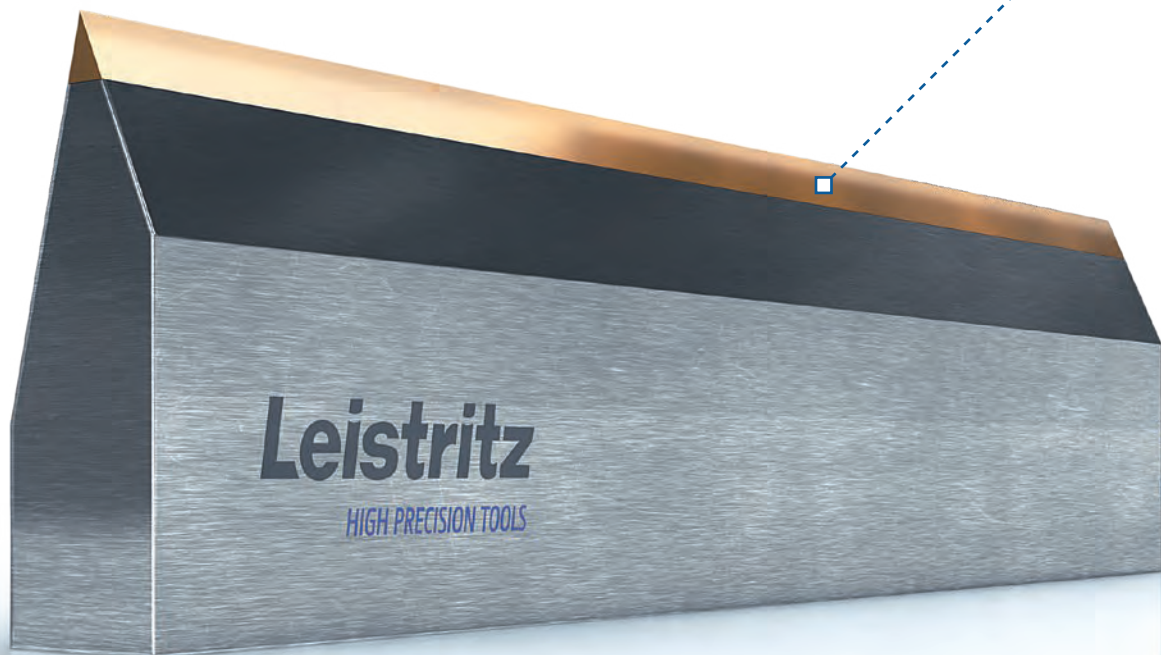
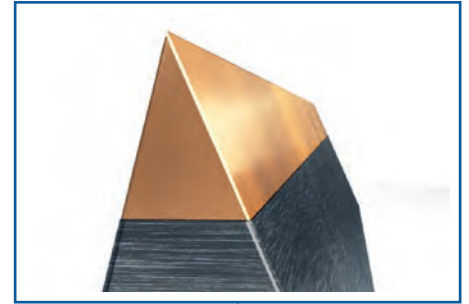

Configure your tool!

LPTline

Learn more about our full range of microtome knives and configure your suitable product!

LPT+line

For special challenges: Request your individual microtome knives directly from us now!



tools.leistritz.com/laboratory



Leistriz**Produktionstechnik GmbH**

Leistrizstrasse 1-11
92714 Pleystein/Opf.
+49 9654 89-0
produktionstechnik@leistriz.com

Leistriz**Advanced Technologies Corp.**

165 Chestnut Street
07401 Allendale, NJ
+1 201 934-8262

**Leistriz Machinery (Taicang)
Co., Ltd. – Shanghai**

Rm. 902, No.400,
Zhejiang Zhong Rd.,
Shanghai 200001
+86 21 63523-268

Leistriz SEA Pte. Ltd.

25 International Business Park
Unit 04-53/54, West Wing,
German Center
609916 Singapur
+65 6569-3395

tools.leistriz.com